

Mounting bases & accessories

Overview

To complete the range of ties, ABB has also developed a wide range of bases, fasteners and accessories to provide a solution professional in current applications in the electrical field.

It is a wide range from classic polyamide 6.6 to high performance ETFE fluoropolymer for applications in harsh conditions.

To suit every application, these products are available in a wide choice of shapes and designs and with different mounting methods ranging from self-adhesive to glue and / or screwing.

ABB now offers, with the range of TC345 type sub-bases, a high-performance technical sub-base:

- New materials and design for improved performance
- A special adhesive formula, especially for nylon bases

Applications:

- Boxes and control devices
- Professional equipment
- Military and medical equipment
- Lighting and electronic equipment



Cable tie mounting bases

Mounting bases

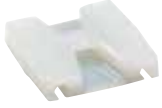

Characteristics

- Available in a variety of materials for both indoor and outdoor use
- One-piece molding — no lost parts
- Adhesive-backed with pressure-sensitive adhesive tape (where applicable)

Technical information

- Material: polyamide 6.6
- Temperature range: 0°C to +66°C (32°F to +150°F)



One-way mounting bases

Std. Cat. N°.	Bulk Cat. N°.	Mounting method	Max tie width accom.		Length L		Width W		Material	Std. pkg. [pcs]	Bulk pkg. [pcs]
			[mm]	[in.]	[mm]	[in.]	[mm]	[in.]			
TC5342A	TC342A	Self-adhesive*	4.8	0.19	28.6	1.13	28.6	1.13	Polyamide 6.6	100	1,000
-	TC342A-X	Self-adhesive*	4.8	0.19	28.6	1.13	28.6	1.13	Weatherable polyamide 6.6	-	1,000
-	TC342	TC2PA	4.8	0.19	28.6	1.13	28.6	1.13	Polyamide 6.6	-	1,000
-	TC342X	TC2PA	4.8	0.19	28.6	1.13	28.6	1.13	Weatherable polyamide 6.6	-	1,000
-	TC342A-FR	Self-adhesive*	4.8	0.19	28.6	1.13	28.6	1.13	Polyamide 6.6	-	1,000

* Synthetic rubber adhesive

Diagram

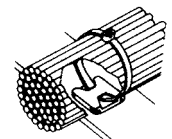
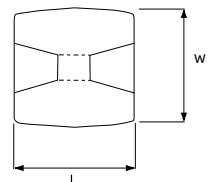

Cable tie mounting bases

Four-way mounting bases



Characteristics

- Eliminates errors in premounting the base with respect to its orientation to wire bundle direction
- Convenient way to mount wire bundles at cross-over points — two optional mounting holes included

Technical information

- Temperature range: 0 °C to +70 °C (32 °F to +158 °F)
- Temperature storage: 0 °C to 48 °C (32°F to 120 °F)
- Mechanical strength: 10lb (44N)

Four-way mounting bases

Std. Cat. N°.	Bulk Cat. N°.	Mounting method	Max tie width accom.		Length L		Width W		Material	Std. pkg. [pcs]	Bulk pkg. [pcs]
			[mm]	[in.]	[mm]	[in.]	[mm]	[in.]			
4-Way Adhesive Mounting Base											
TC5345A	TC345A	Self-adhesive*	4,8	0,19	28,6	1,13	28,6	1,13	Polyamide 6.6	100	1,000
TC5345AX	TC345AX	Self-adhesive*	4.8	0.19	28.6	1.13	28.6	1.13	Weatherable polyamide 6.6	100	1,000
-	TC345	TC2PA/screws	4.8	0.19	28.6	1.13	28.6	1.13	Polyamide 6.6	-	1,000
4-Way Mini Base											
TC050X050A-C	TC050X050A	Self-adhesive*	2.5	0.10	12.7	0.5	12.7	0.5	Polyamide 6.6	100	1,000
TC050X050AX-C	TC050X050AX	Self-adhesive*	2.5	0.10	12.7	0.5	12.7	0.5	Weatherable polyamide 6.6	100	1,000
TC5344A	TC344A	Self-adhesive*	3.6	0.14	19.1	0.75	19.1	0.75	Polyamide 6.6	100	1,000
TC5344AX	TC344AX	Self-adhesive*	3.6	0.14	19.1	0.75	19.1	0.75	Weatherable polyamide 6.6	100	1,000
TC5344	TC344	Screw Mount	3.6	0.14	19.1	0.75	19.1	0.75	Polyamide 6.6	100	1,000
Large 4-Way Base											
TC150X150L	TC150X150	Screw Mount	4.8	0.19	38.1	1.5	38.1	1.5	Polyamide 6.6	50	500
TC150X150A-L	TC150150A	Self-adhesive*	4.8	0.19	38.1	1.5	38.1	1.5	Polyamide 6.6	50	500
TC150X150AX-L	TC150X150AX	Self-adhesive*	4.8	0.19	38.1	1.5	38.1	1.5	Weatherable polyamide 6.6	50	500
TC200X200-L	TC200X200	Screw Mount	7.6	0.30	50.8	2.0	50.8	2.0	Polyamide 6.6	50	500
TC200X200A-L	TC200X200A	Self-adhesive*	7.6	0.30	50.8	2.0	50.8	2.0	Polyamide 6.6	50	500
-	TC200X200AX	Self-adhesive*	7.6	0.30	50.8	2.0	50.8	2.0	Weatherable polyamide 6.6	-	500
-	TC368	Screw Mount	19.1	0.75	50.8	2.0	50.8	2.0	Polyamide 6.6	-	500
-	TC368A	Self-adhesive*	19.1	0.75	50.8	2.0	50.8	2.0	Polyamide 6.6	-	500

* Synthetic rubber adhesive

Diagram

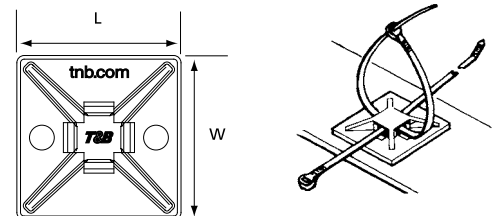

Cable tie mounting bases

2-way entry



Characteristics

- Can be used in 2-way entry style for cable ties having a width up to 7.6mm (0.30in.)
- For cable ties having a width up to 4.8mm (0.19in.), the mounting bases can be used in 4-way entry style
- Choice of 3 materials: standard Polyamide 6.6 (natural), UV-resistant polyamide 6.6 (black), Polyamide 6.6 flame retardant and ETFE Fluoropolymer (aquamarine)
- Supplied either on a rubber based (synthetic polymer) closed cell foam adhesive (installation: self-adhesive and/or screw) or without self-adhesive (installation: screw and/ or 2-component glue**)

Technical information

TC347, TC347A, TC5347AR, TC347X et TC5347AX

- Material: polyamide 6.6
- Temperature range: -40°C to +85°C (-40°F to 185°F)
(Self-adhesive version: 0°C to +65°C/32°F to -85°F)

- Flammability rating: UL 94 V-2
- UV-resistant (black), Halogen free, Silicone free

TC347FR (Flame retardant)

- Material: polyamide 6.6
- Temperature range: -40°C to +85°C (-40°F to +185°F)
- Flammability rating: UL 94 V-0
- Halogen free, silicone free

TCZ347 (Fluoropolymère)

- Material: ETFE Fluoropolymer
- Temperature range: -46°C to +150°C (-50.8°F to +302°F)
- Flammability rating: UL 94 V-0
- Silicone free, inert to most solvents and chemicals, hydrolytically stable, radiation resistant

2-way entry

Cat. n°.	Colour	Mounting method	Dimensions				For tie		Mounting		Std. pkg. [pcs]		
			L		W		width up to		hole diameter				
			[mm]	[in.]	[mm]	[in.]	[mm]	[in.]	[mm]	[in.]	[mm]	[in.]	
TC347	Natural	Screw / glue**	7.8	0.31	28.6	1.13	28.6	1.13	7.6	0.30	4.4 (2x)	0.17 (2x)	1,000
TC347X	UV-resistant black	Screw / glue**	7.8	0.31	28.6	1.13	28.6	1.13	7.6	0.30	4.4 (2x)	0.17 (2x)	1,000
TC347FR	Natural/ flame retardant	Screw / glue**	7.8	0.31	28.6	1.13	28.6	1.13	7.6	0.30	4.4 (2x)	0.17 (2x)	1,000
TCZ347	Aquamarine	Screw / glue**	7.8	0.31	28.6	1.13	28.6	1.13	7.6	0.30	4.4 (2x)	0.17 (2x)	500
TC5347AR / TC347A	Natural	Self-adhesive*/ screw	8.5	0.34	29.0	1.14	29.0	1.14	7.6	0.30	4.4 (2x)	0.17 (2x)	100 / 1,000
TC5347AX	UV-resistant black	Self-adhesive*/ screw	8.5	0.34	29.0	1.14	29.0	1.14	7.6	0.30	4.4 (2x)	0.17 (2x)	100

* Synthetic rubber adhesive

** Glue = Cat. no. TC2PA (see page C92 for specifications)

Diagram

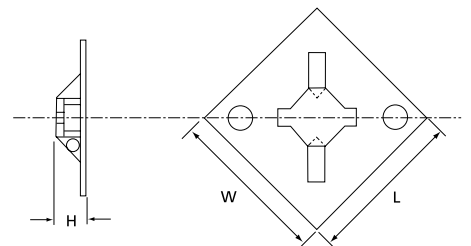

Cable tie mounting bases

One-piece mounting clamp



Characteristics

- Provides a fast and convenient method of securing bundles
- Single-piece design offers reduced installation time and maximized inventory control
- Integral top cover incorporates a unique ratchet design that is fully adjustable and releasable
- Available in a pressure-sensitive adhesive or screw mount design

Technical information

- Material: polyamide 6.6
- Temperature range: 0°C to +66°C (32°F to +150°F)
- Colour: Natural
- Flammability rating: UL 94 V-2
- Halogen free, silicone free

One-piece mounting clamp

Std. Cat. N°.	Bulk Cat. N°.	Mounting method	Dimensions										Std. pkg. [pcs]	Bulk pkg. [pcs]
			Height H		L	E Height of clamping area from ... to		F Width of clamping area		Mounting hole diameter				
			[mm]	[in.]		[mm]	[in.]	[mm]	[in.]	[mm]	[in.]	[mm]	[in.]	
TC5349A-TB	TC349A-TB	Self-adhesive*	14.5	0.57	25.0	0.98	4.6 à 8.9	0.18 à 0.35	6	0.24	-	-	100	1,000
TC5350A-TB	TC350A-TB	Self-adhesive*	22.0	0.87	25.0	0.98	5 à 11.4	0.20 à 0.45	15	0.59	4.3	0.17	100	1,000

* Synthetic rubber adhesive

Diagrams

TC349A-TB
TC5349A-TB

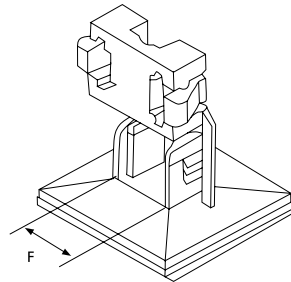

TC350A-TB
TC5350A-TB

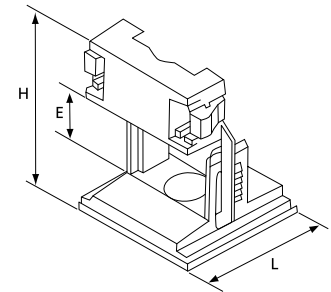

Cable tie mounting bases

Aluminum mounting plates



Characteristics

- Compact
- 650-41349 has two holes for mounting
- Light
- Long life at extreme temperatures

Technical information

- Material: aluminium (3003, ASTM-B-209)
- Temperature range: -100°C to +450°C (+212°F to +842°F)
- Colour: metal
- Flammability rating: flame resistant
- UV resistant

Aluminum mounting plates

Cat. n°.	Mounting method	For tie width up to	Max. Length of the tie		Width L		Std. pkg. [pcs]
			[mm]	[in.]	[mm]	[in.]	
TC105	Screw / glue*	0.19	25.4	1.00	13.2	0.52	1,000
650-41349*	Screw / glue*	0.19	34.9	1.38	9.5	0.37	1,000

* Glue = Cat. no. TC2PA (see below for specifications)

Diagram

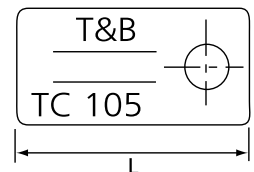

2-component glue

TC2PA



Characteristics

- 2 component glue
- Consists of one tube each of adhesive and activator
- Easy application
- Stable and durable adhesion
- Applicable on all Polyamide and Aluminium mounting bases and cable clamps
- Also applicable on concrete and other porous surfaces
- UV resistant

Cat. n°.	Mounting method	Std. pkg. [pcs]
TC2PA	Consists of one tube each, adhesive and activator	1

Cable tie mounting bases

Adhesive Mounting Cradle



Characteristics

- Accepts cable ties up to 50-lb. (222 N) tensile strength (miniature through standard)
- Supplied on closed cell foam with synthetic rubber-based adhesive
- Use #6 self-tapping screw for added strength if desired

Technical information

- Material: polyamide 6.6
- Temperature range: 0°C to +49°C (32°F to +120°F)
- Flammability rating: UL 94 V-2
- Colour: Natural
- Halogen free, silicone free

Adhesive Mounting Cradle

Std. Cat. N°.	Bulk Cat. N°.	Mounting method	Dimensions				For tie width up to		Std. pkg. [pcs]	Bulk pkg. [pcs]		
			H		L		W					
			[mm]	[in.]	[mm]	[in.]	[mm]	[in.]				
MCNY-1250-9-C	MCNY-1250-9-D	Self-adhesive*	7.2	0.28	31.7	1.25	25.4	1	7.6	0.30	100	500

* Synthetic rubber adhesive

Diagrams

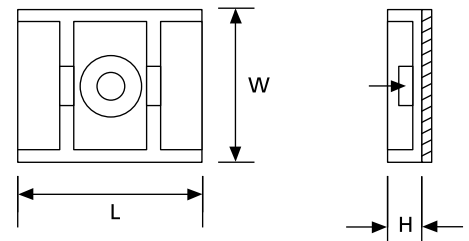

Cable tie mounting bases

Saddle support – Screw mount



Characteristics

- Tie mounting bases with supporting saddle
- For screw- or rivet-mounting
- The prism-shape of the saddle prevents twisting around the fixture
- High strength through compact design
- Non-conductive, non-corrosive, resistant to fuels lubricants and most chemicals

Technical information

- Material: Polyamide 6.6 or heat stabilised
- Temperature range: -40°C to +105°C (-40°F to +221°F)
- Flammability rating: UL 94 V-2
- Colour: UV-resistant black
- Halogen free, silicone free

Saddle support – Screw mount

Cat. n°	Mounting method	Dimensions								For tie width up to	Mounting hole diameter		Std. pkg. [pcs]	
		H		W		L		D			[mm]	[in.]		
		[mm]	[in.]	[mm]	[in.]	[mm]	[in.]	[mm]	[in.]	[mm]	[in.]	[mm]	[in.]	
SMNY-001-0-D	Screw n° 6 and n° 8	7.1	0.28	9.8	0.39	15.2	0.60	4.7	0.19	4.8	0.19	4.2	0.17	500

Diagrams

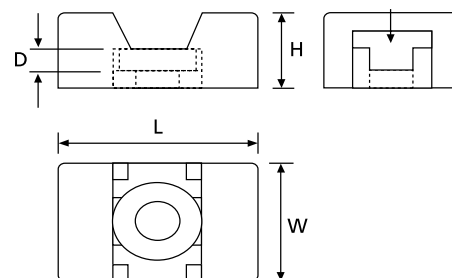

Cable tie mounting bases

Saddle support



Characteristics

- Tie mounting bases with supporting saddle
- For screw- or rivet-mounting
- The prism-shape of the saddle prevents twisting around the fixture
- High strength through compact design
- Non-conductive, non-corrosive, resistant to fuels, lubricants and most chemicals
- Available in natural nylon, UV-resistant nylon or heat stabilised black version

Technical information

- Material: Polyamide 6.6 or heat stabilised Polyamide 6.6
- Temperature range: -40°C to +85°C (-40°F to +185°F) (Natural)
- Mounting method: Screw or rivet
- Flammability rating: UL 94 V-2
- Halogen free, silicone free



Saddle support

Std. Cat. N°.	Bulk Cat. N°.	Colour	Dimensions								For tie width up to	Mounting hole diameter		Std. pkg. [pcs]	Bulk pkg. [pcs]	
			H		W		L		D			[mm]	[in.]			
			[mm]	[in.]	[mm]	[in.]	[mm]	[in.]	[mm]	[in.]	[mm]	[in.]	[mm]	[in.]		
TC5140	TC140	Natural	6.7	0.26	8.7	0.34	14.2	0.56	1.8	0.07	2.4	0.09	3.0	0.12	100	500
TC5141	TC141**	Natural	7.5	0.30	11.1	0.44	17.0	0.67	2.3	0.09	4.8	0.19	3.8	0.15	100	500
TC5142	TC142	Natural	10.7	0.42	14.2	0.56	23.4	0.92	2.9	0.11	7.6	0.30	5.2	0.20	100	500
TC5142X*	TC142X*	Black	10.7	0.42	14.2	0.56	23.4	0.92	2.9	0.11	7.6	0.30	5.2	0.20	100	500

* Are not UL recognised

** Add suffix "FR" for flame retardant material (TC141 only)

For other colors and packaging, please contact the sales department
Color black UV resistant and heat stabilized

Diagrams

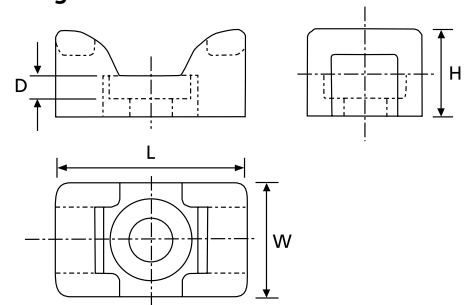

Mounting bases

Screw-mounted - for crosswise fastening



Technical information

- Material - Moulding: Polyamide 6.6 or Polypropylene
- Temperature range: -40°C to +85°C (-40°F to +185°F)
- Colour: Blue
- Halogen free, silicone free

2-way and 4-way entry mounting bases

Std. Cat. N°.	Bulk Cat. N°.	Width		Length		Mounting hole (2x diameter)		Mounting method	For tie width up to		Std. pkg. [pcs]	Bulk pkg. [pcs]
		[mm]	[in.]	[mm]	[in.]	[mm]	[in.]		[mm]	[in.]		
TC5344A-NDT	TC344A-NDT	19.1	0.75	19.1	0.75	3	0.12	self-adhesive*/screw	3.6	0.14	100	1,000
TC5344A-PDT	-	19.1	0.75	19.1	0.75	3	0.12	self-adhesive*/screw	3.6	0.14	100	-
TC5347A-NDT	TC347A-NDT	29	1.14	29	1.14	4.4	0.17	self-adhesive*/screw	7.6	0.30	100	1,000
TC5347A-PDT	-	29	1.14	29	1.14	4.4	0.17	self-adhesive*/screw	7.6	0.30	100	-

* Surface preparation: surface should be cleaned with alcohol-based cleaner before application.
Installation: Surface must be clean and dry prior to application of accessory.
Allow 15-minute setting time for maximum adhesion performance of synthetic rubber adhesive (SRA).

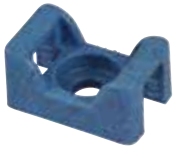

Saddle support

Technical information

- Material - Moulding: Polyamide 6.6 or Polypropylene
- Temperature range: -40°C to +85°C (-40°F to +185°F)
- Colour: Blue
- Halogen free, silicone free

Std. Cat. N°.	Bulk Cat. N°.	Width		Length		Mounting hole diameter		Mounting method	For tie width up to		Std. pkg. [pcs]	Bulk pkg. [pcs]
		[mm]	[in.]	[mm]	[in.]	[mm]	[in.]		[mm]	[in.]		
TC5141-NDT	TC141-NDT	11.1	0.44	17	0.67	3.8	0.15	screw	4.8	0.19	100	500
TC5141-PDT	-	11.1	0.44	17	0.67	3.8	0.15	screw	4.8	0.19	100	-
TC5142-NDT	TC142-NDT	14.2	0.56	23.4	0.92	5.2	0.20	screw	7.6	0.30	100	500
TC5142-PDT	-	14.2	0.56	23.4	0.92	5.2	0.20	screw	7.6	0.30	100	-

Mounting bases

Screw-mounted - for crosswise fastening



Technical information

- Material - Moulding: Polyamide 6.6 or Polypropylene
- Temperature range: -40°C to +85°C (-40°F to +185°F)
- Colour: Blue
- Halogen free, silicone free

Screw-mounted miniature bases

Std. Cat. N°.	Bulk Cat. N°.	Width		Length		Mounting hole				Mounting method	For tie width up to		Std. pkg. [pcs]	Bulk pkg. [pcs]
		[mm]	[in.]	[mm]	[in.]	Diameter D1		Diameter D2			[mm]	[in.]		
TC5102-NDT	TC102-NDT	12.7	0.5	19.1	0.75	4.4	0.17	8.7	0.32	screw #8	4.8	0.19	100	1,000
TC102-PDT	-	12.7	0.5	19.1	0.75	4.4	0.17	8.7	0.32	screw #8	4.8	0.19	-	1,000

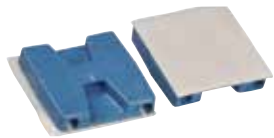

Low profile plates

Std. Cat. N°.	Bulk Cat. N°.	Width		Length		Mounting method	For tie width up to		Std. pkg. [pcs]	Bulk pkg. [pcs]
		[mm]	[in.]	[mm]	[in.]		[mm]	[in.]		
TC5342A-NDT	TC342A-NDT	29	1.14	29	1.14	self-adhesive*	4.8	0.19	100	1,000
TC5342A-PDT	-	29	1.14	29	1.14	self-adhesive*	4.8	0.19	100	-

* Surface preparation: surface should be cleaned with alcohol-based cleaner before application.

Installation: Surface must be clean and dry prior to application of accessory.

Allow 15-minute setting time for maximum adhesion performance of synthetic rubber adhesive (SRA).

Technical information

- Material - Moulding: Polyamide 6.6 or Polypropylene
- Temperature range: -40°C to +85°C (-40°F to +185°F)
- Colour: Blue
- Halogen free, silicone free

Cable tie mounting bases

Screw-mounted strips for multiple bundling



Characteristics

- Tie mounting strips for up to 6 bundles simultaneously
- When mounted, the tie is guided through the clamp for fast assembly

Cat. n°. TC1101 to TC1117

- Simple and strong flat mounting beams for fixing multiple cables, bundles or components
- Mil. Specified (MS-3339-....-...)

Cat. n°. TC375 and TC376

- For vertical and double-side mounting

Technical information

- Material: polyamide 6.6
- Temperature range : -40°C to +85°C (-40°F to +185°F)
- Colour: Natural
- Mounting method (TC1101 to TC1117): 2 or more screw #6
- Mountin method (TC375 & TC376): 1 screw #8
- Flammability rating: UL 94 V-2
- Halogen free, silicone free

Screw-mounted strips for multiple bundling



Cat. n°.	H		W		L		D		E		For tie width up to		Mounting hole diameter		Std. pkg. [pcs]	Mil. Spec.
	[mm]	[in.]	[mm]	[in.]	[mm]	[in.]	[mm]	[in.]	[mm]	[in.]	[mm]	[in.]	[mm]	[in.]		
TC1101	3.2	0.13	12.7	0.5	44.0	1.73	31.8	1.25	9.5	0.37	4.8	0.19	3.7	0.15	100	●
TC1102	3.2	0.13	12.7	0.5	76.0	2.99	31.8	1.25	9.5	0.37	4.8	0.19	3.7	0.15	100	●
TC1103	3.2	0.13	12.7	0.5	108.0	4.25	31.8	1.25	9.5	0.37	4.8	0.19	3.7	0.15	100	●
TC1104	3.2	0.13	12.7	0.5	140.0	5.51	31.8	1.25	9.5	0.37	4.8	0.19	3.7	0.15	100	●
TC1105	3.2	0.13	12.7	0.5	171.0	6.73	31.8	1.25	9.5	0.37	4.8	0.19	3.7	0.15	100	●
TC1112	5.2	0.20	15.9	0.63	244.0	9.61	38.1	1.5	14.3	0.56	7.6	0.30	3.7	0.15	100	●
TC1113	5.2	0.20	15.9	0.63	53.3	2.10	38.1	1.5	14.3	0.56	7.6	0.30	3.7	0.15	100	●
TC1114	5.2	0.20	15.9	0.63	91.4	3.60	38.1	1.5	14.3	0.56	7.6	0.30	3.7	0.15	100	●
TC1115	5.2	0.20	15.9	0.63	130.0	5.12	38.1	1.5	14.3	0.56	7.6	0.30	3.7	0.15	100	●
TC1116	5.2	0.20	15.9	0.63	168.0	6.61	38.1	1.5	14.3	0.56	7.6	0.30	3.7	0.15	100	●
TC1117	5.2	0.20	15.9	0.63	206.0	8.11	38.1	1.5	14.3	0.56	7.6	0.30	3.7	0.15	100	●
TC375	19.1	0.75	17.5	0.69	93.0	3.66	-	-	6.4	0.25	4.8	0.19	4.8	0.19	100	-
TC376	17.0	0.67	17.5	0.69	44.0	1.73	-	-	6.4	0.25	4.8	0.19	4.8	0.19	100	-

* Black, UV resistant

Application



Diagrams

TC375 and TC376

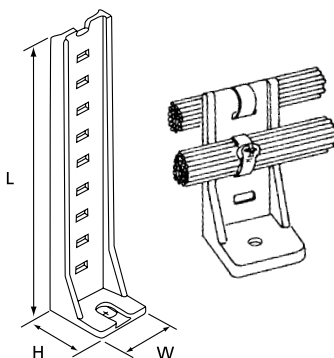

TC1101 ... TC1117

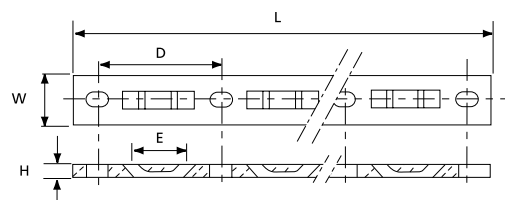

Cable tie mounting bases

Screw-mounted strips for multiple bundling



Characteristics

- Provides a mounting range for bundles from ¼ in. through 4 in. in diameter
- During assembly, the clip is guided through the base for quick assembly
- One mounting hole is slotted to permit adjustment of the bundle position up to the time of actual bundle installation.

Technical information

- Material: polyamide 6.6
- Temperature range: -40°C to +85°C (-40°F to +185°F)
- Colour: Natural
- Mounting method: 2 screws
- Flammability rating: UL 94 V-2
- Halogen free, silicone free



Screw-mounted strips for multiple bundling

Std. Cat. N°.	Dimensions				For tie width up to		Mounting hole diameter		Mounting method	Std. pkg. [pcs]
	W		L		[mm]	[in.]	[mm]	[in.]		
	[mm]	[in.]	[mm]	[in.]						
TC101	12.7	0.5	50.0	1.97	4.8	0.19	5.2	0.20	Screw #10	1,000
TC103	15.8	0.62	79.0	3.11	7.6	0.30	6.9	0.27	Screw ¼ in.	500

Diagrams

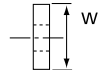
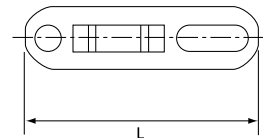
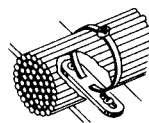

Cable tie mounting bases

Right-angle bundle support



Characteristics

- Supporting mounting base with strong hold thanks to 2 mounting holes
- Can be screwed or riveted
- Allows double and/or crosswise (two ties) fixing
- For parallel and through mounting with support
- Suitable for large bundle diameters
- Meets military specs as a support in bulkheads and walls (MS3341).

Technical information

- Material: polyamide 6.6
- Temperature range: -40°C to +85°C (-40°F to +185°F)
- Colour: Natural
- Mounting method: 2 screws or 2 rivetsts
- Flammability rating: UL 94 V-2
- Halogen free, silicone free

Right-angle bundle support

Cat. n°	Dimensions						For tie width up to	Mounting hole diameter		Mounting method	Std. pkg. [pcs]	
	H		W		L			[mm]	[in.]			
	[mm]	[in.]	[mm]	[in.]	[mm]	[in.]	[mm]	[in.]	[mm]	[in.]		
TC106	25.4	1	19.1	0.75	25.4	1	7.6	0.30	3.3	0.13	2 screws #4	200
TC109	11.1	0.44	9.9	0.39	14.3	0.56	4.8	0.19	2.4	0.09	2 screws #2	1,000

Diagrams

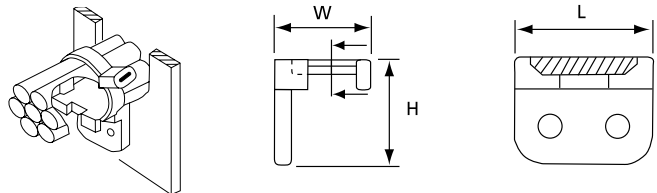

Cable tie mounting bases

Aluminum siding clip



Characteristics

- Designed to accommodate metal siding
- Accommodates wires both vertically and/or horizontally
- Provision for utilizing Ty-Rap cable ties to secure large diameter bundles

Technical information

- Material: polycarbonate
- Colour: transparent
- Weather-resistant



Weather
resistant

Aluminum siding clip

Cat. n°.	Wire Accommodation	Std. pkg. [pcs]
TC201	1/8 in. diameter wire (2-pair station wire)	100

Diagrams

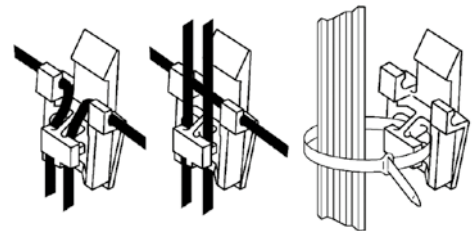

Cable tie mounting bases

Screw-mounted - for wide cable ties



Characteristics

- Extremely low profile
- For screw- or rivet-mounting
- Easy to use thanks to the cable tie insertion guide
- Secure fixing with 2 fastening holes

Technical information

- Material: polyamide 6.6
- Temperature range: -40°C to +85°C (-40°F to +185°F)
- Colour: Natural
- Mounting method: 2 screws
- Mechanical force : 50lbs (222N)
- Flammability rating: UL 94 V-2
- Halogen free, silicone free



Screw-mounted - for wide cable ties

Cat. n°	Dimensions										Std. pkg. [pcs]	
	H		W		L		For tie width up to		Mounting hole diameter			Mounting method
	[mm]	[in.]	[mm]	[in.]	[mm]	[in.]	[mm]	[in.]	[mm]	[in.]		
TC815-TB	6.4	0.25	19.1	0.75	31.2	1.23	7.6	0.30	5.3	0.21	Screw n° 10	1,000

Diagrams

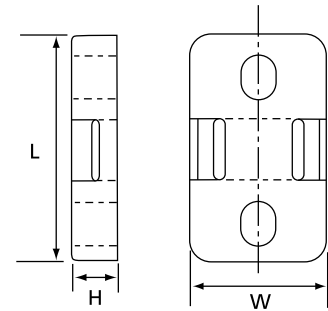
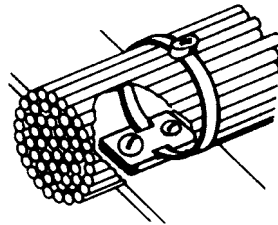

Cable tie mounting bases

Low-profile two-way miniature mounting bases



Characteristics

- Extremely low profile
- For screw- or rivet-mounting
- Easy to use thanks to the cable tie insertion guide
- Threaded nut allows the screw to come from outside the mounting surface

Technical information

- Material: polyamide 6.6
- Temperature range: -40°C to +85°C (-40°F to +185°F)
- Colour: Natural
- Mounting method: Screw or rivet
- Flammability rating: UL 94 V-2
- Halogen free, silicone free



E49405

Low-profile two-way miniature mounting bases

Std. Cat. N°.	Bulk Cat. N°.	Dimensions								Mounting method	For tie width up to		Std. pkg. [pcs]	Bulk pkg. [pcs]
		Height H		Length L		Width W		Mounting hole diameter			[mm]	[in.]		
		[mm]	[in.]	[mm]	[in.]	[mm]	[in.]	[mm]	[in.]					
TC502	TC102	3.2	0.13	19	0.75	12.7	0.50	4.4	0.17	Screw #8	4.8	0.19	100	1,000
-	TC104	2.4	0.09	10	0.40	7.9	0.31	3.4	0.13	Screw #5	2.4	0.09	-	1,000
-	TC804-TB	2.4	0.09	10	0.40	7.9	0.31	2.3	0.09	Screw #2	2.4	0.09	-	1,000
-	TC112-TB	4.7	0.19	19	0.75	9.5	0.38	4.4	0.17	Screw #8	4.8	0.19	-	1,000
-	TC812-TB	4.7	0.19	19	0.75	9.5	0.38	5.1	0.20	Screw #10	4.8	0.19	-	1,000
-	TC814-TB	4.7	0.19	19	0.75	9.5	0.38	3.3	0.13	Screw #5	4.8	0.19	-	1,000

Diagrams

TC804-TB

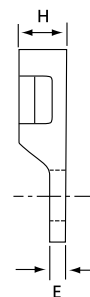
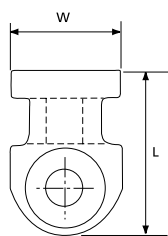

TC112-TB
TC812-TB
TC814-TB

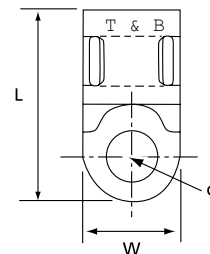

Cable tie mounting bases

Miniature mounting base



Characteristics

- Low profile
- Easy to use

Technical information

- Material: polyamide 6.6
- Temperature range: -40°C to +85°C (-40°F to +185°F)
- Flammability rating: UL 94 V-2
- Colour: Natural
- Halogen free, silicone free



Miniature mounting base

Cat. n°.	Mounting method	Height		Width		Length			For tie width up to	Std. pkg.
		[mm]	[in.]	[mm]	[in.]	[mm]	[in.]	[mm]	[in.]	[pcs]
TC817-TB	TC2PA	4.8	0.19	11.0	0.43	11.0	0.43	4.8	0.19	1,000

Diagram

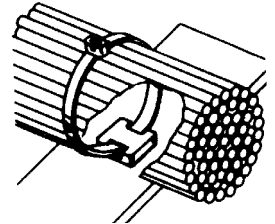

Cable tie mounting bases

Low-profile four-way mounting base



Characteristics

- Extremely low profile
- For screw- or rivet-mounting
- Easy to use thanks to the cable tie insertion guide
- Two ties can be fastened crosswise to securely fix cable intersections

Technical information

- Material: polyamide 6.6
- Temperature range: -40°C to +85°C (-40°F to +185°F)
- Colour: Natural
- Mounting method: Screw or rivet
- Flammability rating: UL 94 V-2
- Halogen free, silicone free

Low-profile four-way mounting base

Std. Cat. N°.	Bulk Cat. N°.	Dimensions						For tie width up to		Mounting hole diameter		Mounting method	Std. pkg. [pcs]	Bulk pkg. [pcs]
		H		W		L				[mm]	[in.]			
		[mm]	[in.]	[mm]	[in.]	[mm]	[in.]	[mm]	[in.]	[mm]	[in.]			
-	TC826-TB	5.7	0.22	12.7	0.5	23.8	0.94	4.8	0.19	4.4	0.17	Screw #8		1,000
TC5828	TC828-TB	3.8	0.15	10.1	0.40	22.5	0.89	4.8	0.19	4.3	0.17	Screw #8	100	1,000

Diagrams

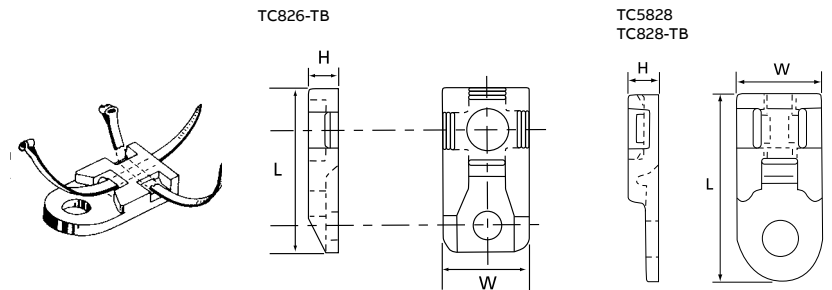

Cable tie mounting bases

Self-riveting base



Characteristics

- Low profile mounting base with integrated rivet
- Easy to install into normal or blind holes: just hammer in the expanding harbour
- Firmly locks into position when projecting pin is pushed into the mounting hole
- Parts are color-coded according to hole diameter to avoid confusion and prevent operator mistakes

Technical information

- Material: polyamide 6.6
- Temperature range: -40°C to +85°C (-40°F to +185°F)
- Mounting method: Rivet mounted
- Flammability rating: UL 94 V-2
- Halogen free, silicone free

Self-riveting base

RU
E49405

Cat. n°	Colour	Dimensions				For tie width up to		Mounting hole diameter		Std. pkg. [pcs]
		[mm]	[in.]	[mm]	[in.]	[mm]	[in.]	[mm]	[in.]	
TC116-TB	Red	12.7	0.5	19.1	0.75	4.8	0.19	3.7	0.15	1,000
TC116-0	Black	12.7	0.5	19.1	0.75	4.8	0.19	3.7	0.15	1,000
TC118-TB	Blue	12.7	0.5	19.1	0.75	4.8	0.19	4.4	0.17	1,000
TC120	Yellow	12.7	0.5	19.1	0.75	4.8	0.19	4.9	0.19	1,000

Diagrams

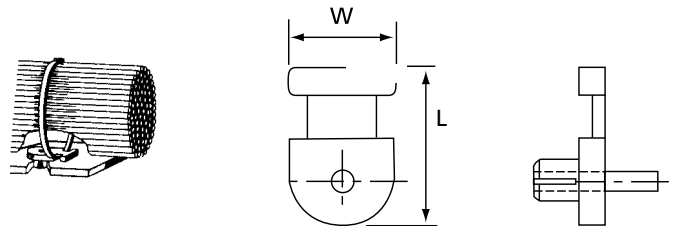

Cable tie mounting bases

Clip-in mounting bases for blind mounting



Characteristics

- Clip-in tie mounting bases for housings, faceplates etc
- With fastening clip for blind-mounting and two openings for 2.8mm (0.11") or 4.8mm (0.19") ties
- Low profile

Technical information

- Material: polyamide 6.6
- Temperature range: -40°C to +85°C (-40°F to +185°F)
- Mounting method: Clip in
- Flammability rating: UL 94 V-2
- Halogen free, silicone free



E49405

Clip-in mounting bases for blind mounting

Cat. n°.	Dimensions								For tie width up to	Mounting hole diameter		Std. pkg. [pcs]	
	[mm]	H [in.]	W [mm]	[in.]	G [mm]	[in.]	F [mm]	[in.]		[mm]	[in.]		
TC121-TB	10,4	0.41	11.2	0.44	3.4	0.13	6.1	0.24	4.8	0.19	6.3	0.25	1,000

Diagrams

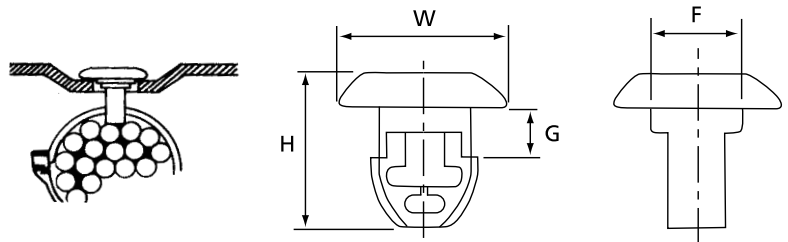

Cable tie mounting bases

Push-in and bolted bases



Characteristics

- Clip-in tie mounting bases for housings, faceplates etc
- With fastening clip for surface mounting
- Low profile
- TC107: Mounting in a threaded hole

Technical information

- Material: polyamide 6.6
- Temperature range: -40°C to +85°C (-40°F to +185°F)
- Colour: Natural
- Mounting method: Clip in or screw
- Flammability rating: UL 94 V-2
- Halogen free, silicone free

Push-in and bolted bases



Std. Cat. N°.	Bulk Cat. N°.	Dimensions						For tie width up to		Size mounting hole	Std. pkg. [pcs]	Bulk pkg. [pcs]
		[mm]	H [in.]	[mm]	W [in.]	[mm]	L [in.]	[mm]	[in.]			
TC5823	TC823-TB	16.8	0.66	11.1	0.44	11.1	0.44	4.8	0.19	¼ in.	100	1,000

Diagrams

