

## Fittings and brackets

### Material

Superstrut fittings and brackets are manufactured from hot rolled carbon steel.

### Dimensions

The following standard dimensions apply to all fittings except as indicated on the individual drawings:

Hole spacing	$1\frac{3}{16}$ in. from end of fittings
Hole spacing	$1\frac{7}{8}$ in. centers
Hole size	$\frac{9}{16}$ in. diameter
Material	$1\frac{5}{8}$ in. wide
Material	$\frac{1}{4}$ in. thick

### Application instructions

Parts drawings illustrate a typical use for the fitting, and in many cases, other uses for the part are appropriate.

### Design data

Load ratings vary depending on whether fittings and brackets are used with 12, 14 or 16 gauge channel. Ratings are shown for each channel material. (See page A66 for engineering data and specifications).

### Nuts and bolts required

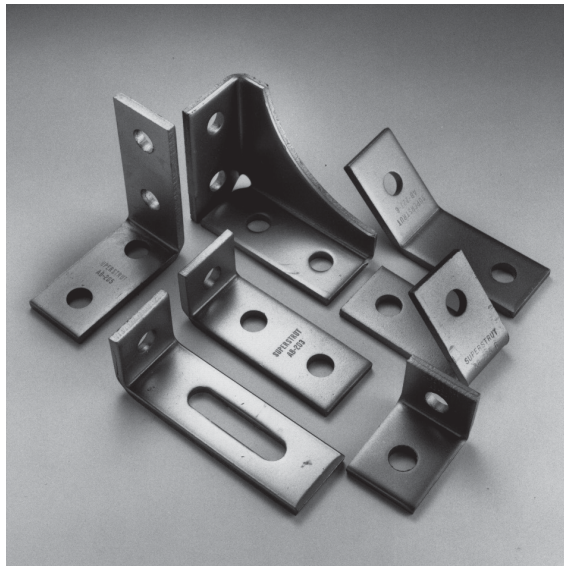

Unless otherwise noted, nuts and bolts for use with fittings and brackets should be ordered separately. The standard bolt for the  $\frac{9}{16}$  in. hole is a  $\frac{1}{2}$  in. hex head cap screw 1 in. long. The 1 in. length may be used with all series channel.

### Design load

For more information on design load, see page A66 for engineering data and specifications.

### Finishes and special materials

Standard finishes are hot-dipped galvanized (HDGC) and GoldGalv® (no suffix). Fittings are also available in electrogalvanized (EG) and stainless steel 316 (SS6C). Contact your regional sales office for availability and minimum quantities.

### Aluminum channel

For aluminum channel, we suggest fittings in HDG (C) or SS6 (C).

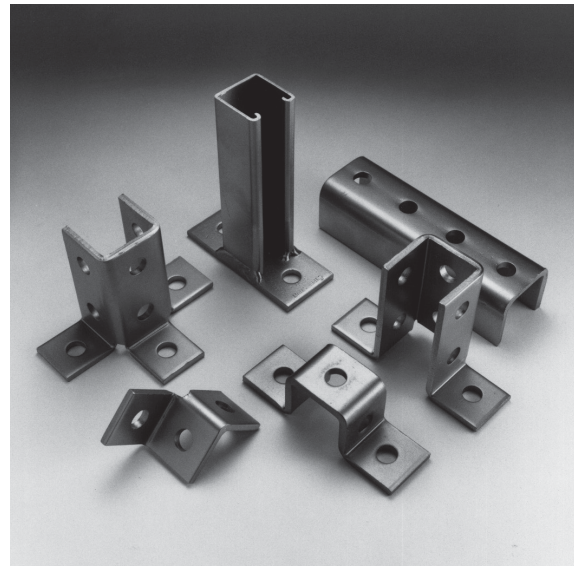

# Fittings and brackets

## Flat fittings

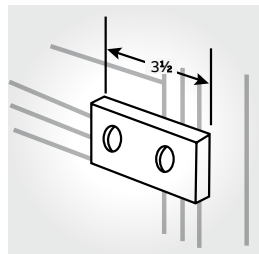

01

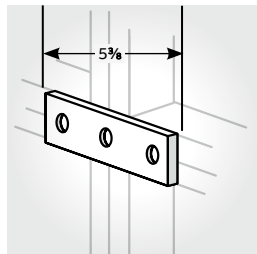

02

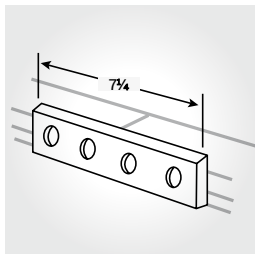

03

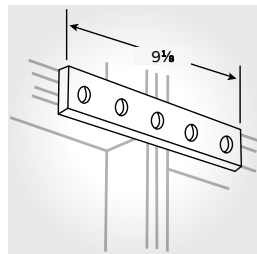

04

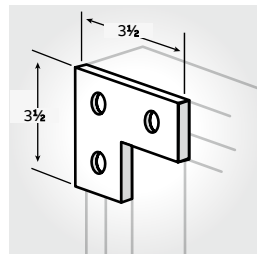

05

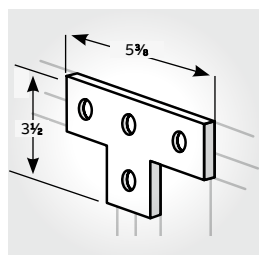

06

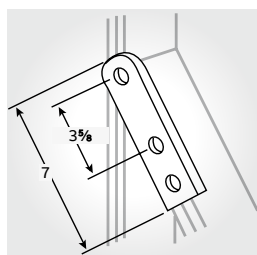

07

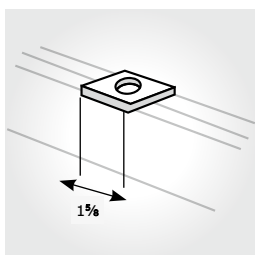

08

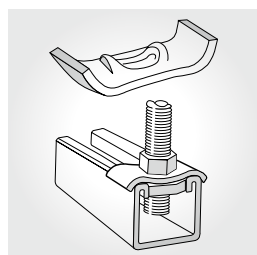

09

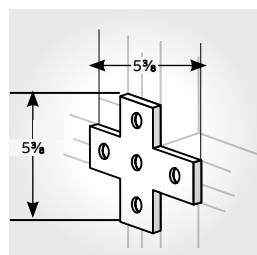

10

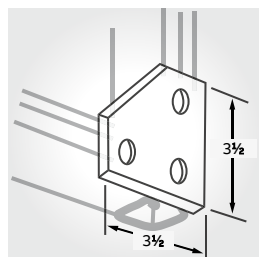

11

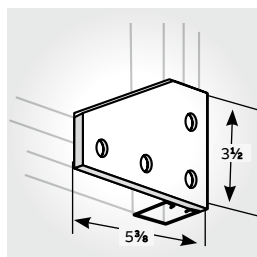

12

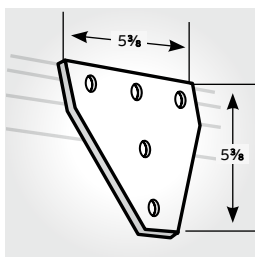

13

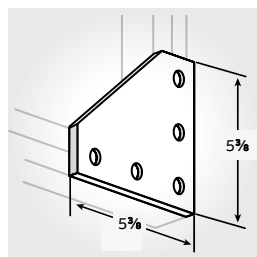

14

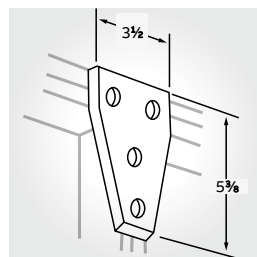

15

01 **AB206**  
AB206HDGC  
AB206EG  
AB206  
AB206SS6C  
Wt./C 35 lb

02 **AB207**  
AB207HDGC  
AB207EG  
AB207  
AB207SS6C  
Wt./C 52 lb

03 **X207**  
X207HDG  
X207EG  
X207  
X207SS6  
Wt./C 78 lb

04 **X208**  
X208HDG  
X208EG  
X208  
X208SS6C  
Wt./C 88 lb

05 **AB219**  
AB219HDGC  
AB219EG  
AB219  
AB219SS6C  
Wt./C 53 lb

06 **AB220**  
AB220HDGC  
AB220EG  
AB220-TB\*  
AB220SS6C  
Wt./C 78 lb

07 **AB240**  
AB240HDG  
AB240EG  
AB240-TB\*  
Wt./C 69 lb

08 **AB241**

Cat. no.	Bolt size (in.)	Wt./C lb
AB241-1/4*	1/4	18
AB241-5/16*	5/16	18
AB241-3/8*	3/8	18
AB241-1/2*	1/2	17
AB241-5/8*	5/8	15
AB241-3/4*	3/4	14

\*Finishes  
• HDGC  
• EG  
• GoldGalv®  
• SS6C

09 **AB242**  
AB242HDGC  
AB242EG  
AB242  
Wt./C 9 lb  
For use with either 3/8 in. or 1/2 in. hanger rod.

10 **AB253**  
AB253HDGC  
AB253EG  
AB253-TB\*  
AB253SS6C  
Wt./C 97 lb

11 **AB255**  
AB255HDGC  
AB255EG  
AB255  
Wt./C 70 lb

12 **AB257**  
AB257HDGC  
AB257EG  
AB257-TB\*  
Wt./C 105 lb

13 **AB261**  
AB261HDGC  
AB261EG  
AB261  
Wt./C 148 lb

14 **AB263**  
AB263HDGC  
AB263EG  
AB263  
AB263SS6  
Wt./C 150 lb

15 **AB265**  
AB265HDGC  
AB265EG  
AB265  
Wt./C 105 lb

### Standard dimensions

Hole spacing	1 3/16 in. from end
Hole spacing	1 7/8 in. centers
Hole size	5/16 in. diam.
Material	1 1/8 in. width
Material	1/4 in. thick

### Materials

HDG(C)	Hot-dipped galvanized
EG(C)	Electrogalvanized
(No suffix)	GoldGalv®
SS6(C)	Stainless steel 316

All dimensions shown are in in.

# Fittings and brackets

## 90° fittings

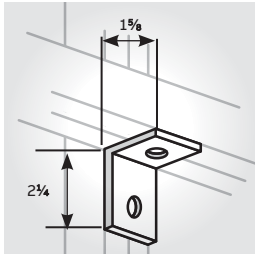

01

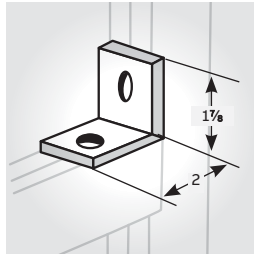

02

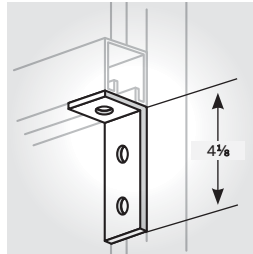

03

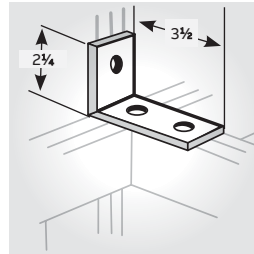

04

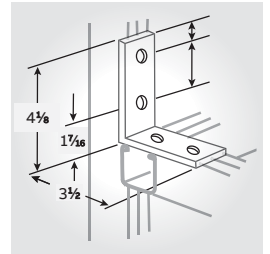

05

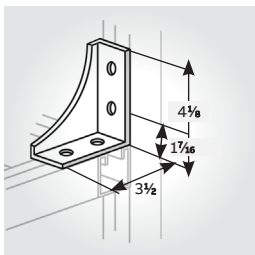

06

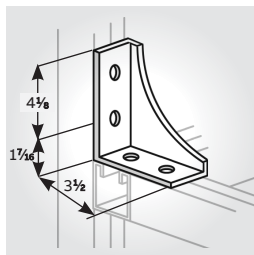

07

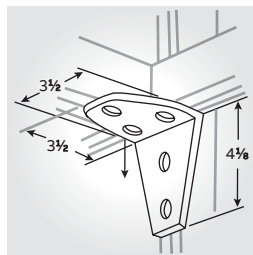

08

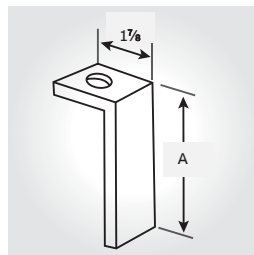

09

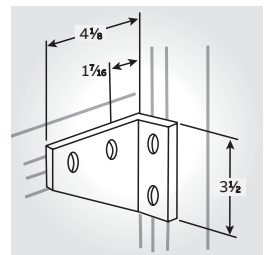

10

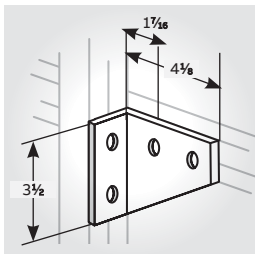

11

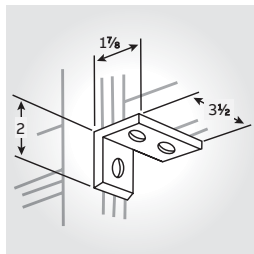

12

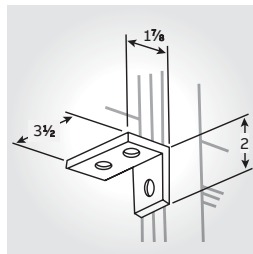

13

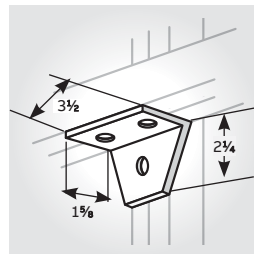

14

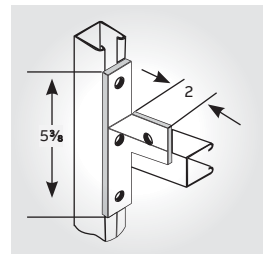

15

01 **AB201**  
AB201HDGC  
AB201EG  
AB201  
AB201SS6C  
Wt./C 35 lb

02 **AB202**  
AB202HDGC  
AB202EG  
AB202  
AB202SS6C  
Wt./C 35 lb

03 **AB203**  
AB203HDGC  
AB203EG  
AB203  
AB203SS6C  
Wt./C 58 lb

04 **AB204**  
AB204HDGC  
AB204EG  
AB204  
AB204SS6  
Wt./C 58 lb

05 **AB205**  
AB205HDGC  
AB205EG  
AB205  
AB205SS6C  
Wt./C 78 lb

06 **AB213**  
AB213HDGC  
AB213EG  
AB213  
Wt./C 125 lb

07 **AB214**  
AB214HDGC  
AB214EG  
AB214  
AB214SS6  
Wt./C 125 lb

08 **AB216**  
AB216HDGC  
AB216EG  
AB216SS6C  
Wt./C 135 lb

Cat. no.	A Wt./C	
	(in.)	lb
AB252-1*	3 7/8	61
AB252-2*	5 7/8	84
AB252-3*	7 7/8	107
AB252-4*	9 7/8	130

\*Finishes  
• HDGC  
• EG  
• GoldGalv®

09 **AB252**  
AB252RHDGC  
AB252REG  
AB252R  
Wt./C 105 lb

10 **AB254R**  
AB254RHDGC  
AB254REG  
AB254R  
Wt./C 105 lb

12 **AB260R**  
AB260RHDGC  
AB260REG  
AB260R  
Wt./C 58 lb

13 **AB260L**  
AB260LHDGC  
AB260LEG  
AB260L  
Wt./C 58 lb

14 **AB274**  
AB274HDGC  
AB274EG  
AB274  
Wt./C 70 lb

15 **AB275**  
AB275HDGC  
AB275EG  
AB275SS6C  
Wt./C 77 lb

### Standard dimensions

Hole spacing	1 3/16 in. from end
Hole spacing	1 7/8 in. centers
Hole size	5/16 in. diam.
Material	1 1/8 in. width
Material	1/4 in. thick

### Materials

HDG(C)	Hot-dipped galvanized
EG(C)	Electrogalvanized
(No suffix)	GoldGalv®
SS6(C)	Stainless steel 316

All dimensions shown are in in.

## Fittings and brackets

### 90° fittings

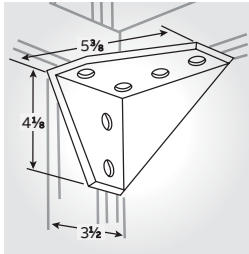

01

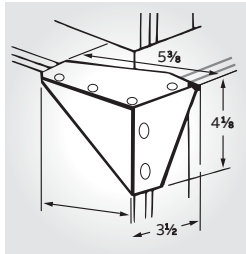

02

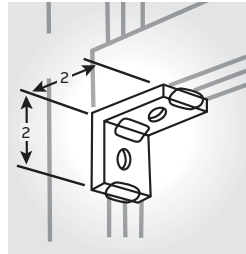

03

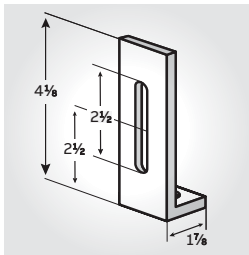

04

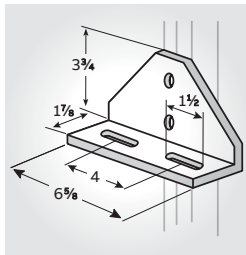

05

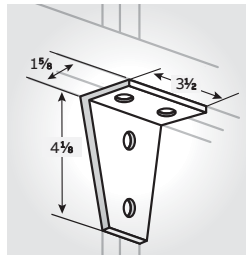

06

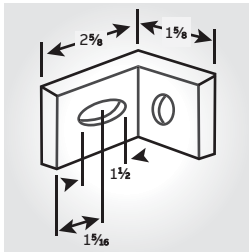

07

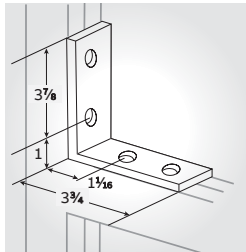

08

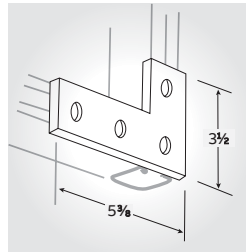

09

01 **AB284R**  
AB284RHDG  
AB284REG  
AB284R  
Wt./C 230 lb

02 **AB284L**  
AB284LHDG  
AB284LEG  
AB284L  
Wt./C 230 lb

03 **AB299**  
AB299HDG  
AB299EG  
AB299  
Wt./C 40 lb

04 **X201**  
X201HDG  
X201EG  
X201  
Wt./C 65 lb

05 **X204**  
X204HDG  
X204EG  
X204  
Wt./C 1-90 lb

06 **X289**  
X289HDG  
X289EG  
X289  
Wt./C 105 lb

07 **X299**  
X299HDG  
X299EG  
X299  
Wt./C 38 lb

08 **N205**  
N205HDG  
N205EG  
N205  
N205SS6C  
Wt./C 74 lb

09 **N219**  
N219HDG  
N219EG  
N219  
N219SS6  
Wt./C 71 lb

### SuperMag™

#### Magnetic fittings for Superstrut metal framing

Powerful, nickel-plated magnets embedded in the most popular Superstrut steel fittings, including square washers, L-brackets, T-brackets and 90° angle brackets, secure the fitting to the strut during assembly. Acting as a third hand, SuperMag fittings allow the installer to work more efficiently and safely with tools and hardware.



#### Magnetic 90° angle fitting,

##### SilverGalv™

#### AB202M EG

2-hole, 1 1/8" H x 2" L (pkg. qty. 50)



#### AB205M EG

4-hole, 4 3/8" H x 3 1/2" L (pkg. qty. 25)



#### Magnetic flat bracket,

##### SilverGalv

#### AB219M EG

L-bracket (pkg. qty. 25)



#### AB220M EG

T-bracket (pkg. qty. 25)



#### Magnetic square washer

##### SilverGalv

#### AB241M 1/4 EG

For 1/4" bolt (pkg. qty. 100)

#### AB241M 3/8 EG

For 3/8" bolt (pkg. qty. 100)

#### AB241M 1/2 EG

For 1/2" bolt (pkg. qty. 100)

All dimensions shown are in in.

Note: The magnets are only intended for use as an installer aid, not as a permanent installation method on their own. Magnetic fittings must be bolted in place following the same standard installation procedures as non-magnetic fittings for permanent installation. Standard finish is SilverGalv (EG). Best for use with traditional or spring channel nuts.

# Fittings and brackets

## Angular and "Z" shape fittings

### Angular fittings

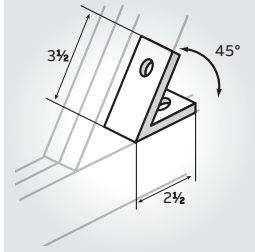

01

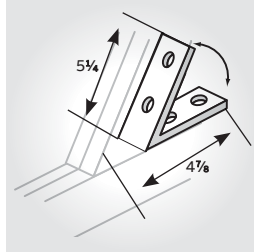

02

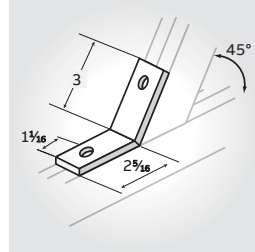

03

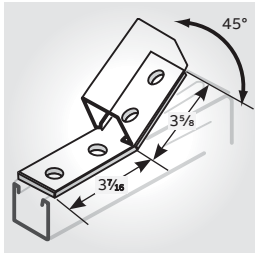

04

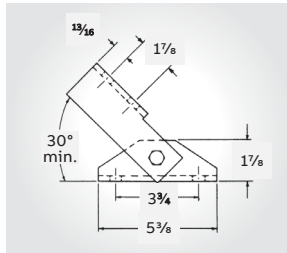

05

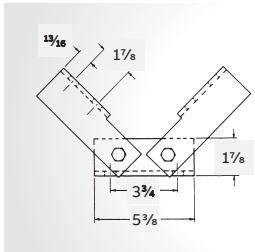

06

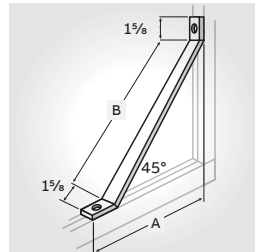
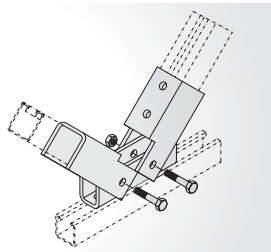

07

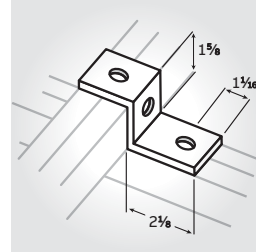

08

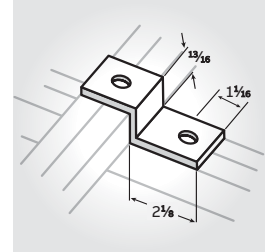

09

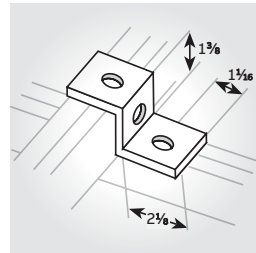

10

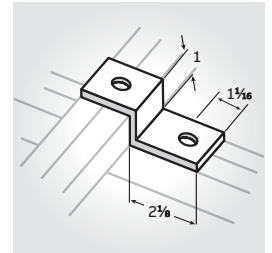

11

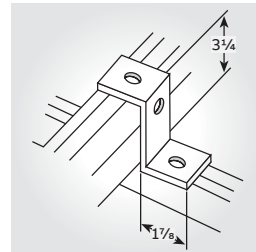

12

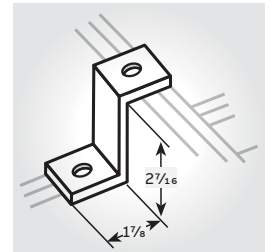

13

### Angular fittings

01 **AB225**  
AB225HDGC  
AB225EG  
AB225  
AB225SS6  
Wt./C 58 lb  
Other angles available.  
Contact your regional sales office.

02 **AB226**  
AB226HDGC  
AB226SS6  
Wt./C 119 lb  
Other angles available.  
Contact your regional sales office.

03 **AB227**  
AB227HDGC  
AB227EG  
AB227  
AB227SS6  
Wt./C 58 lb  
Other angles available.  
Contact your regional sales office.

04 **AB228**  
AB228HDGC  
AB228SS6C  
Wt./C 69 lb  
Other angles available.  
Contact your regional sales office.

05 **AB231**  
AB231EG

06 **AB232**  
AB232EG

07 **AB239**  
\*Finishes  
• HDGC  
• EG  
• GoldGalv®

### "Z" shaped fittings

08 **A209**  
A209HDGC  
A209EG  
A209  
A209SS6  
Wt./C 55 lb  
For attaching A and AR series channel.

09 **B209**  
B209HDG  
B209EG  
B209  
Wt./C 43 lb  
For attaching B and BR series channel.

10 **C209**  
C209  
Wt./C 49 lb  
For attaching C series channel.

11 **D209**  
Wt./C 45 lb  
For attaching D series channel.

12 **CZ209**  
For attaching H series and A back to back.

13 **EZ209**  
EZ209HDGC  
EZ209EG  
EZ209  
EZ209SS6  
For attaching E series channel.

Cat. no.	A (in.)	B (in.)	Wt./C lb
AB239-1*	7 13/16	8 1/2	148
AB239-2*	13 3/4	17	255
AB239-3*	19 3/4	25 1/2	363

### Standard dimensions

Hole spacing	1 3/16 in. from end
Hole spacing	1 7/8 in. centers
Hole size	5/16 in. diam.
Material	1 1/8 in. width
Material	1/4 in. thick

### Materials

HDG(C)	Hot-dipped galvanized
EG(C)	Electrogalvanized
(No suffix)	GoldGalv®
SS6(C)	Stainless steel 316

All dimensions shown are in in.

# Fittings and brackets

## “U” shape fittings

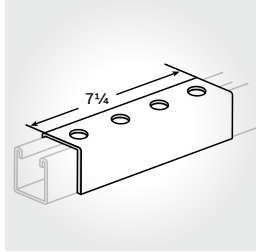

01

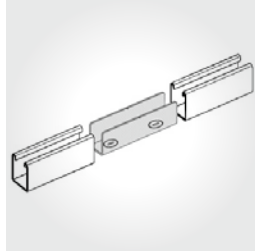

02

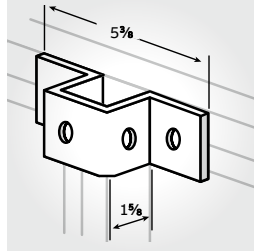

03

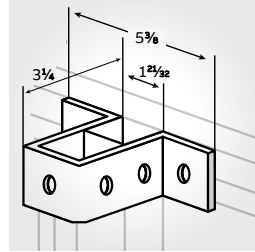

04

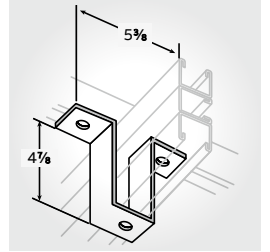

05

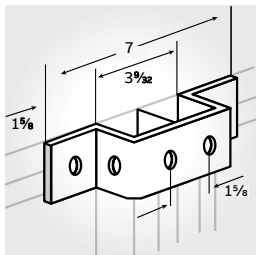

06

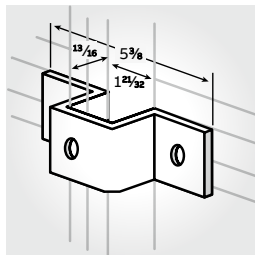

07

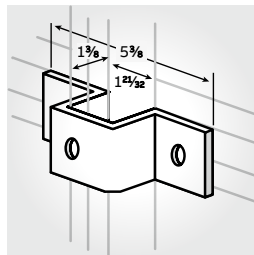

08

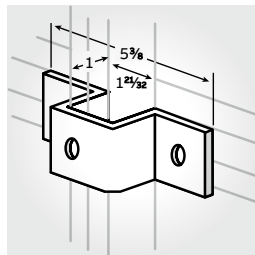

09

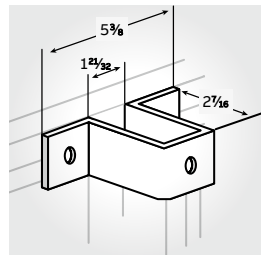

10

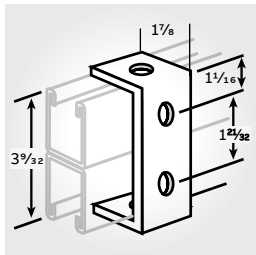

11

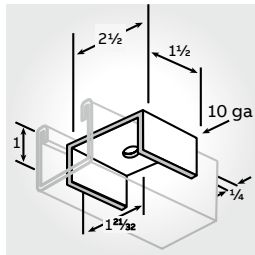

12

01 **A208**  
A208HDGC  
A208EG  
A208  
A208SS6C  
Wt./C 275 lb  
Does not include stud nut or bolts.  
For A and AR series channel.

02 Inside Strut joiner  
**SJ-12-PG** for series A1200 joiner  
c/w 2 set screws  
finish pre-galv.

**SJ-14-PG** for series A1400 joiner  
c/w 2 set screws  
finish pre-galv.

**A213** Inside joiner  
For A1200 Series.  
Available only in GoldGalv® finish.

03 **A210**  
A210HDGC  
A210EG  
A210  
A210SS6C  
Wt./C 88 lb  
For attaching A and AR series channel.

04 **A211**  
A211HDGC  
A211EG  
A211  
Wt./C 128 lb  
For attaching A and AR series double channel, and H series.

05 **AN211**  
AN211HDG  
AN211EG  
AN211  
Wt./C 181 lb

06 **A212**  
A212HDG  
A212EG  
A212  
A212SS6  
Wt./C 113 lb

07 **B210**  
B210HDG  
B210EG  
B210  
B210SS6  
Wt./C 65 lb  
For attaching B and BR series.

08 **C210**  
C210HDG  
C210EG  
C210  
Wt./C 77 lb  
For attaching C series channel.

09 **D210**  
D210HDG  
D210EG  
D210  
D210SS6  
Wt./C 71 lb  
For attaching D series channel.

10 **E210**  
E210HDGC  
E210EG  
E210  
Wt./C 112 lb  
For attaching E series channel.

11 **AB245**  
AB245HDG  
AB245EG  
AB245  
Wt./C 70 lb  
For attaching A and AR series double channel.

12 **AB288**

Cat. No.	Bolt	
	size (in.)	Wt./C lb
AB288-3/8*	3/8	37
AB288-1/2*	1/2	37
AB288-5/8*	5/8	37

\*Finishes  
• HDGC  
• EG  
• GoldGalv®

### Standard dimensions

Hole spacing	13/16 in. from end
Hole spacing	1 7/8 in. centers
Hole size	5/16 in. diam.
Material	1 5/8 in. width
Material	1/4 in. thick

### Materials

HDG(C)	Hot-dipped galvanized
EG(C)	Electrogalvanized
(No suffix)	GoldGalv®
SS6(C)	Stainless steel 316

All dimensions shown are in in.

# Fittings and brackets

## Wing fittings

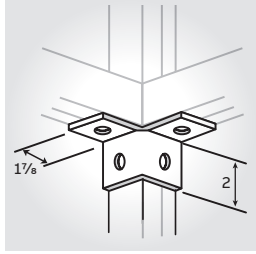

01

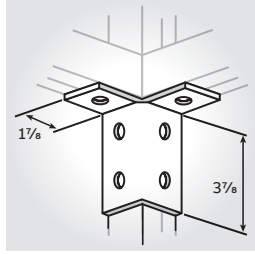

02

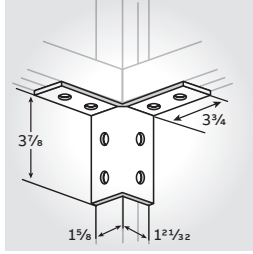

03

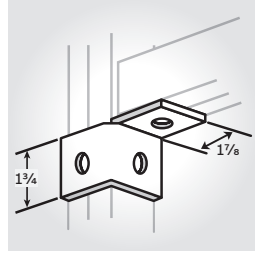

04

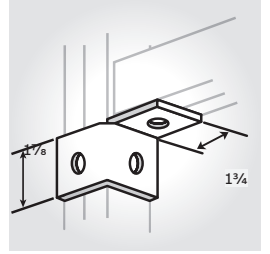

05

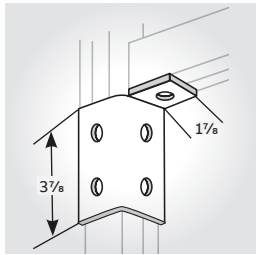

06

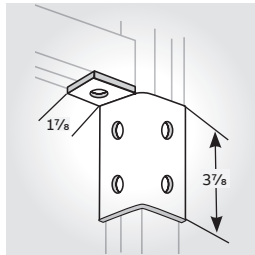

07

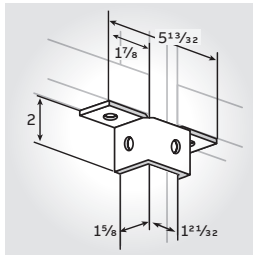

08

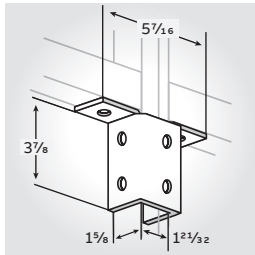

09

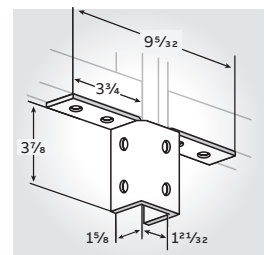

10

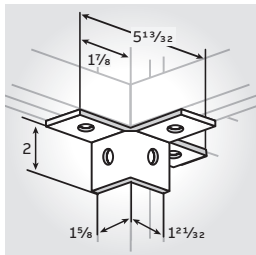

11

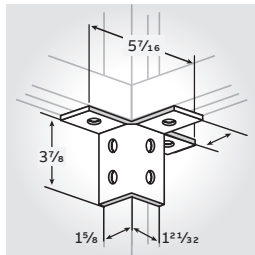

12

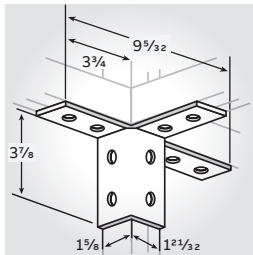

13

- 01 **AW204**  
AW204SS6  
AW204HDG  
AW204EG  
AW204  
Wt./C 76 lb
- 02 **AW214**  
AW214HDG  
AW214EG  
AW214  
Wt./C 115 lb
- 03 **A217**  
AW217HDG  
A217EG  
A217  
Wt./C 155 lb

- 04 **AW205L**  
AW205LHDG  
AW205LEG  
AW205L  
Wt./C 59 lb
- 05 **AW205R**  
AW205REG  
AW205R  
Wt./C 59 lb
- 06 **AW215L**  
AW215LHDG  
AW215LEG  
AW215L  
Wt./C 98 lb

- 07 **AW215R**  
AW215RHDG  
AW215REG  
AW215R  
Wt./C 98 lb
- 08 **AW220**  
AW220HDG  
AW220EG  
AW220  
Wt./C 90 lb
- 09 **AW224**  
AW224HDG  
AW224EG  
AW224  
Wt./C 147 lb

- 10 **AW219**  
AW219HDG  
AW219EG  
AW219  
Wt./C 187 lb
- 11 **AW226**  
AW226SS6  
AW226HDG  
AW226  
Wt./C 113 lb
- 12 **A218**  
A218HDG  
A218EG  
A218  
Wt./C 177 lb

- 13 **AW228**  
AW228HDG  
AW228EG  
AW228  
Wt./C 230 lb

Standard dimensions	
Hole spacing	1 3/16 in. from end
Hole spacing	1 7/8 in. centers
Hole size	9/16 in. diam.
Material	1 5/8 in. width
Material	1/4 in. thick
Materials	
HDG(C)	Hot-dipped galvanized
EG(C)	Electrogalvanized
(No suffix)	GoldGalv®
SS6(C)	Stainless steel 316
All dimensions shown are in inches (in.)	

# Fittings and brackets

## Brackets

### S202

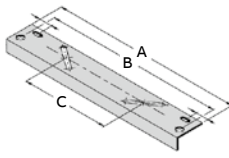
	Cat. no.	A (in.)	B (in.)	C (in.)	Wt./C lb
Diagram 	S202-6*	6	5	-	75
	S202-9*	9	8	2	100
	S202-15*	15	14	18	175
	S202-21*	21	20	14	250
	S202-27*	27	26	20	325
	S202-33*	33	32	26	400

\*Finishes  
• HDG

### S249

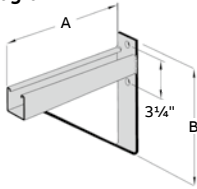
	Cat. no.	A (in.)	B (in.)	Uniform load/lb	Wt./C lb
Diagram 	S249-8*	8½	8	1,600	320
	S249-14*	14½	9	1,325	520
	S249-20*	20½	9	1,000	660

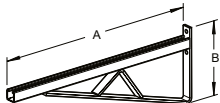
	Cat. no.	A (in.)	B (in.)	Uniform load/lb	Wt./C lb
Diagram 	S249-26*	26½	11½	850	870
	S249-32*	32½	11½	750	1,030
	S249-38*	38½	11½	600	1,230

\*Finishes  
• HDG  
• SS6C

### S251

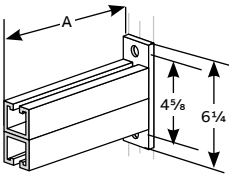
	Cat. no.	A (in.)	Uniform load/lb	Wt./C lb
Diagram 	S251-12*	12	1,650	514
	S251-14*	14½	1,650	514
	S251-18*	18	1,050	714
	S251-20*	20½	1,050	714
	S251-24*	24	800	914
	S251-26*	26½	800	914
	S251-30*	30	650	1,114
	S251-32*	32½	650	1,114
	S251-36*	36	500	1,314
	S251-38*	38½	500	1,314

\*Finishes  
• HDG  
• SS6C

### S203

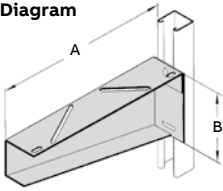
	Cat. no.	A (in.)	B (in.)	Uniform load/lb	Wt./C lb
Diagram 	S203-8*	8½	4½ <sup>16</sup>	325	180
	S203-14*	14½	5¾	325	325
	S203-20*	20½	6 <sup>11</sup> <sub>16</sub>	325	525
	S203-26*	26½	8	325	675
	S203-32*	32½	8	325	840
	S203-38*	38½	8	325	1,050

\*Finishes  
• HDG

### S250

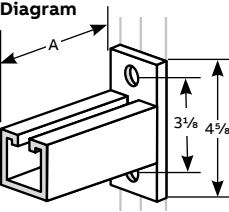
	Cat. no.	A (in.)	Uniform load/lb	Wt./C lb
Diagram 	S250-6*	6	1,500	150
	S250-8*	8½	1,500	150
	S250-12*	12	800	250
	S250-14*	14½	800	250
	S250-18*	18	550	350
	S250-20*	20½	550	350
	S250-24*	24	400	450
	S250-26*	26½	400	450

\*Finishes  
• HDG  
• SS6C

May be installed inverted with no change in load ratings.

### S256

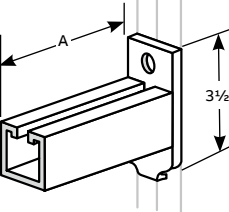
	Cat. no.	A (in.)	Uniform load/lb	Wt./C lb
Diagram 	S256-6*	6	1,000	151
	S256-8*	8½	1,000	151
	S256-12*	12	500	251
	S256-14*	14½	500	251
	S256-18*	18	300	351
	S256-20*	20½	300	351
	S256-24*	24	250	451
S256-26*	26½	250	451	

\*Finishes  
• HDG  
• SS6C

When installed in inverted position reduce load rating 40%.

Standard dimensions	
Hole spacing	19 <sup>16</sup> / <sub>16</sub> in. from end
Hole spacing	1 <sup>7</sup> / <sub>8</sub> in. centers
Hole size	9 <sup>16</sup> / <sub>16</sub> in. diam.
Material	1 <sup>1</sup> / <sub>8</sub> in. width
Material	3 <sup>16</sup> / <sub>16</sub> in. thick

Materials	
HDG(C)	Hot-dipped galvanized
EG(C)	Electrogalvanized
(No suffix)	GoldGalv®
SS6(C)	Stainless steel 316



# Fittings and brackets

## Brackets

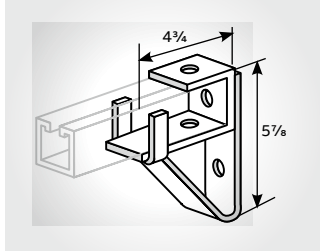

01

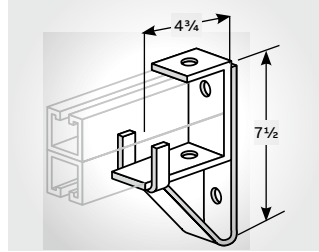

02

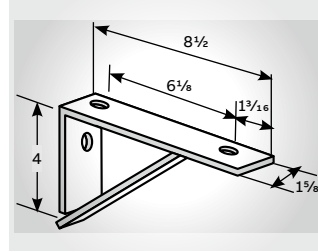

03

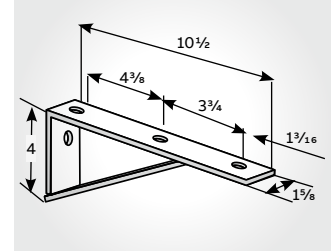

04

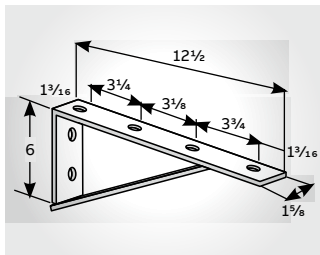

05

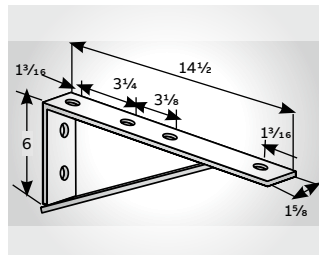

06

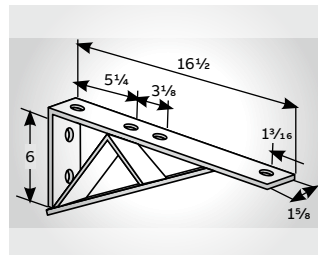

07

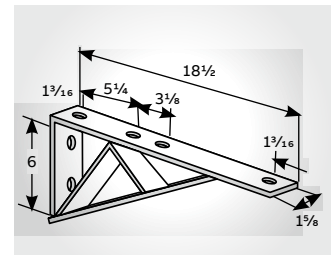

08

01 **S247**  
S247HDG  
S247  
S247SS6  
Design moment  
(channel upright  
as shown)  
When supported by  
A-1200 5,250 inch lb  
A-1400 3,650 inch lb  
Applies to fitting  
only, not to the arm.

02 **S248**  
S248HDG  
S248  
Design moment  
(channel upright  
as shown)  
When supported by  
A-1202 10,800 inch lb  
A-1402 7,550 inch lb  
Applies to fitting  
only, not to the arm.

03 **S204**  
S204HDG  
S204  
Wt./C 174 lb

Design uniform load/lb	
A-1200	750
A-1400	500

04 **S205**  
S205HDG  
S205  
Wt./C 264 lb

Design uniform load/lb	
A-1200	750
A-1400	500

05 **S217**  
S217HDG  
S217  
S217SS6  
Wt./C 264 lb

Design uniform load/lb	
A-1200	750
A-1400	650

06 **S218**  
S218HDG  
S218  
Wt./C 295 lb

Design uniform load/lb	
A-1200	750
A-1400	650

07 **S222**  
S222HDG  
S222  
Wt./C 385 lb

Design uniform load/lb	
A-1200	1,000
A-1400	750

08 **S226**  
S226HDG  
S226-TB\*\*  
Wt./C 421 lb  
\*\*GoldGalv

Design uniform load/lb	
A-1200	1,000
A-1400	750

### Standard dimensions

Hole spacing	1 3/16 in. from end
Hole spacing	1 7/8 in. centers
Hole size	5/16 in. diam.
Material	1 5/8 in. width
Material	1/4 in. thick

### Materials

HDG(C)	Hot-dipped galvanized
EG(C)	Electrogalvanized
(No suffix)	GoldGalv®
SS6(C)	Stainless steel 316

All dimensions shown are in in.

# Fittings and brackets

## Post bases

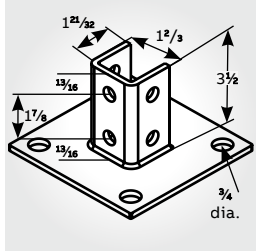

01

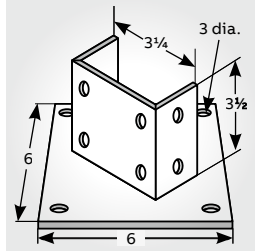

02

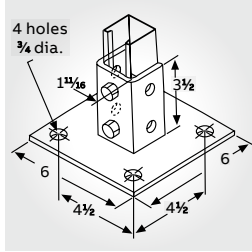

03

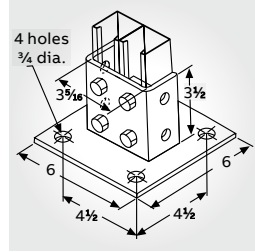

04

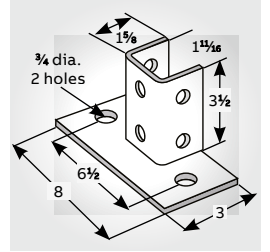

05

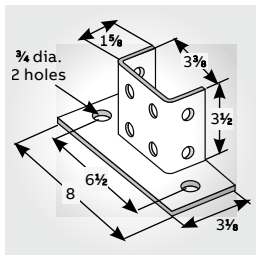

06

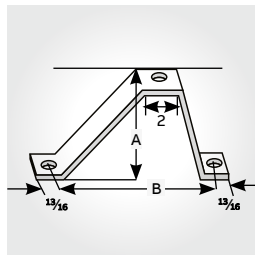

07

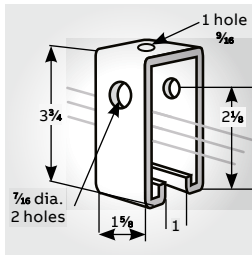

08

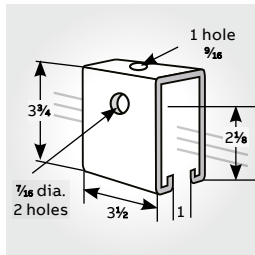

09

01 **AP232**  
AP232HDGC  
AP232EG  
AP232  
Wt./C 384 lb

02 **AP235**  
AP235HDGC  
AP235EG  
AP235-TB\*\*  
Wt./C 400 lb  
\*\*GoldGalv

03 **AP232SQ**  
AP232SQHDGC  
AP232SQEG  
AP232SQSS6  
Wt./C 384 lb

04 **AP235SQ**  
AP235SQHDGC  
AP235SQEG  
AP235SQ  
AP235SQSS6  
Wt./C 400 lb

05 **AP232FL**  
AP232FLHDG  
AP232FLEG  
AP232FL  
Wt./C 272 lb

06 **AP235FL**  
AP235FLEG  
AP235FL  
Wt./C 360 lb

07 **AN270**  
\*Finishes  
• HDG  
• EG

08 **TS272 Track support**  
TS272HDG  
Requires 3/8 in. x 2 1/2 in. bolt and nut (not included)  
Design load: 1,000 lb  
Wt./C 104 lb

09 **TS273 Track support**  
TS27  
For use over channel splice  
Requires 3/8 in. x 2 1/2 in. bolt and nut (not included)  
Design load: 2,000 lb  
Wt./C 228 lb

All dimensions shown are in in.

Cat. no.	A	B	Wt./C lb
AN270-1*	2 3/8	6	113
AN270-2*	4 3/8	8	151
AN270-3*	6 3/8	10	199
AN270-4*	8 3/8	12	246
AN270-5*	10 3/8	14	293

## Fittings and brackets

### Special application fittings and brackets

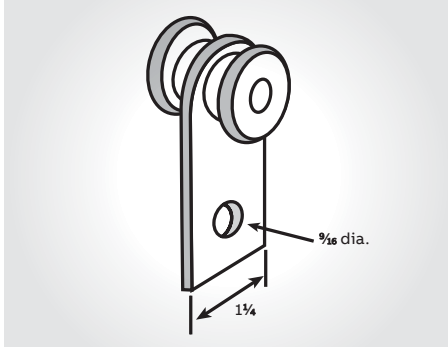

01

**01 TR292**  
 Can be used for series A, E and H channels only. Standard finish is electrogalvanized. Frictionless needle bearings. Design load: 500 lb Safety factor of 5. Wt./C 59 lb

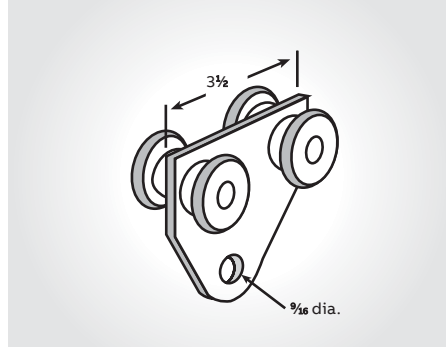

02

**02 TR294**  
 Can be used for series A, E and H channels only. Standard finish is electrogalvanized. Frictionless needle bearings. Design load: 1,000 lb Safety factor of 5. Wt./C 106 lb

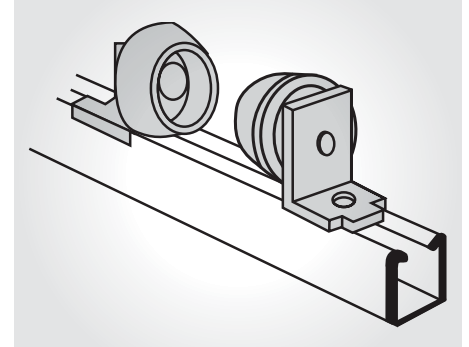

03

**03 C728 Pipe roller (pair)**  
 Cast aluminum rollers, steel brackets. Designed for standard saddles. Order separately for each pair of rollers: two 1/2 in. x 3/16 in. hex head cap screws and two 1/2 in. channel nuts. Space to suit O.D. of pipe and wrapping. Design load: 2,350 lb Wt./C : 300 lb

## Adjustable universal support

Support building services and access equipment on flat roofs and flat surfaces

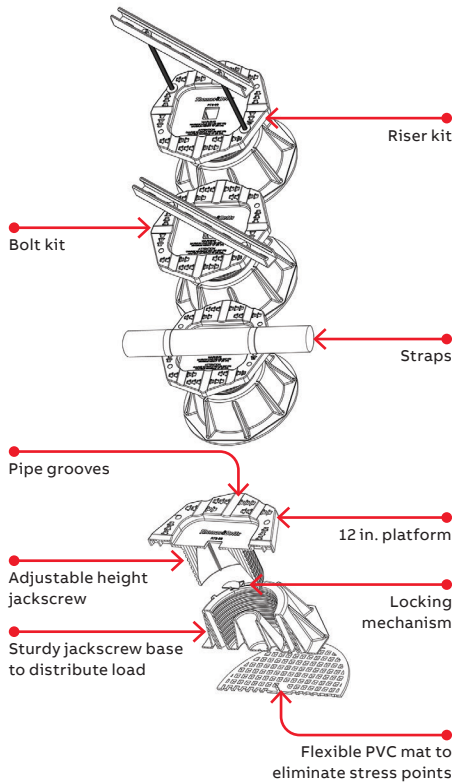

The ABB adjustable universal support (AUS) provides an easy method for supporting pipes, conduit and equipment on flat roofs, below raised floors and even on level ground applications. The AUS reduces installation time compared to other support solutions such as wooden blocks, cement blocks, straps and clips. These labor-intensive solutions also increase the danger of roof membrane penetration.

The AUS system allows for tool-free adjustment of the pedestal height from 6 to 9 inches with a twist of the wrist. This ensures that the supported objects

or pipes are uniformly supported and no high stress supports are carrying a disproportionate load in a single location.

Cat. no.	Description	Qty.
AUS14-96	Adjustable universal support (base only)	1
AUS-RISER-KIT	Riser kit	
A1200HS100PG	14 in. strut	1
H104-1/2X10EGC	12 in. threaded rod	2
E145-1/2EGC	Nut	8
E147-1/2EGC	Washer	8
E148-1/2EGC	Lock washer	4
AUS-STRUT-KIT	Bolt kit	
A1200HS100PG	14 in. strut	1
E142-1/2X200EGC	Bolt	2
E145-1/2EGC	Nut	2
E147-1/2EGC	Washer	4
E148-1/2EGC	Lock washer	2
AUS125PCSS6	4 1/2 in. stainless steel 316 strap (to restrain 1 1/4 in. pipe)	2
AUS150PCSS6	5 in. strap (to restrain 1 1/2 in. pipe)	2
AUS200PCSS6	6 in. strap (to restrain 2 in. pipe)	2